



Side-by-Side Refrigerators

FFSS2614Q S/P/E

26 Cu. Ft. Standard-Depth



Product Dimensions

Height (Including Hinges & Rollers)	69-5/8"
Width (Doors)	36"
Depth (Including Door)	31-3/4"

More Easy-To-Use Features

Bright Lighting

Our bright lighting makes it easy to see what's inside.

Slide-Out Freezer Basket

Adjustable Gallon Door Bins

Full-Width Freezer Shelf

Gives you more usable space to organize and store more.

Ready-Select® Controls

Easily select options with the touch of a button.

Available in:



Stainless (S)



Pearl (P)



Ebony (E)

Signature Features

Adjustable Interior Storage

Over 100 ways to organize and customize your refrigerator.

PureSource® Ultra Water Filtration

Clean, pure, refreshing water that removes impurities straight from your refrigerator.

SpillSafe® Glass Shelves

Slide-out for easy access and are designed to keep spills contained, making them easy to clean.

Store-More™ Capacity

Our large capacity refrigerator gives you room to store more.

Features	
Door Design	UltraSoft™
Door Handle Design	Color-Coordinated
Cabinet Finish	Black (S), Color-Coordinated (P/E)
Door Stops/Door Closers	Yes/Yes
Door Hinge Covers	Black (S), Color-Coordinated (P/E)
Rollers - Front/Rear	Yes/Yes
Energy Saver Plus Technology	Yes
Water Filter Location	Top Right Rear
Sound Package	Quiet Pack
Dispenser	
Controls	Ready-Select®
Dispenser Design	Short, 2-Paddle
Number of Dispenser Buttons	4
Crushed Ice/Cube Ice/Chilled Water	Yes/Yes/No
Ice Option/Freeze Option	
Display On/Off Option	
Lock/Light	No/Yes
Temp/Door Ajar/Power Failure Alerts	
Water Filter Change Indicator Light	
Air Filter Change Indicator Light	
Refrigerator Features	
Interior Lighting	Bright
Water Filter Type	PureSource 3®
Air Filter Type	
Fixed Shelves	2 SpillSafe®
Sliding Shelves	1 SpillSafe®
Cool Zone™ Drawer	
Wine/Can Rack	
Upper Crisper/Lower Crisper	1 Clear/1 Clear
Humidity Controls	
Dairy Compartment	1 Clear
Fixed Door Bins	2 Two-Liter White
Adjustable Door Bins	2 One-Gallon White
Non-Slip Bin Liner/Bottle Retainers	
Condiment Bin	
Freezer Features	
Door Bins/Tilt-Out Wire Door Bins	4 White/No
Fixed Shelves	1 Flip-Out/2 Wire
Full Extension Baskets	
Full Freezer Baskets	1 Plastic
Half Freezer Baskets	
Ice Cream Shelf/Pizza Shelf	
SpaceSaver™ Shelf	
Lighting	Bright
Specifications	
Total Capacity (Cu. Ft.)	26.0
Refrigerator Capacity (Cu. Ft.)	16.5
Freezer Capacity (Cu. Ft.)	9.5
Power Supply Connection Location	Right Bottom Rear
Water Inlet Connection Location	Left Bottom Rear
Voltage Rating	120V/60Hz/15A
Connected Load (kW Rating) @ 120 Volts¹	1.02
Amps @ 120 Volts	8.5
Minimum Circuit Required (Amps)	15
Shipping Weight (Approx.)	293 Lbs.

¹For use on adequately wired 120V, dedicated circuit having 2-wire service with a separate ground wire. Appliance must be grounded for safe operation.

Standard Refrigerator Depth vs. Counter Depth

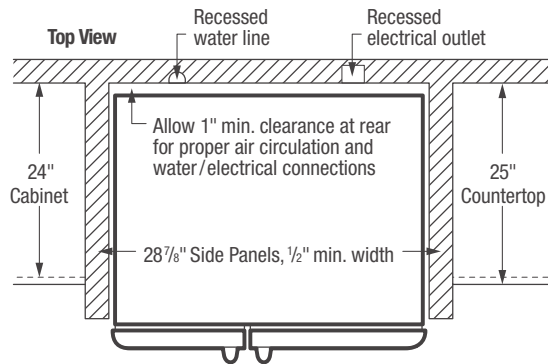
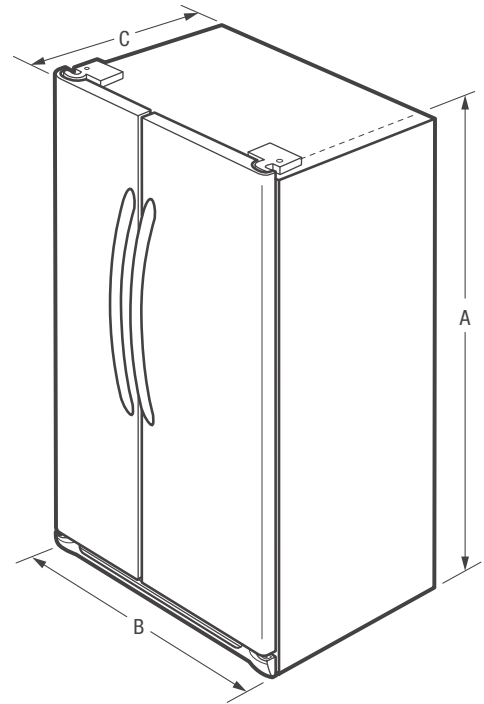
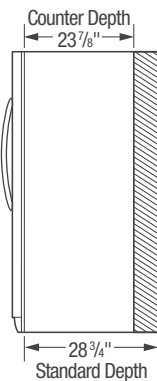

NOTE: For planning purposes only. Always consult local and national electric and plumbing codes. Refer to Product Installation Guide for detailed installation instructions on the web at frigidaire.com.



Product Dimensions	
A - Height (Incl. Hinges & Rollers)	69-5/8"
B - Cabinet Width/Door Width	35-5/8" / 36"
C - Depth (Incl. Door)	31-3/4"
Depth with Door Open 90°	49-1/2"

Accessories information available on the web at frigidaire.com

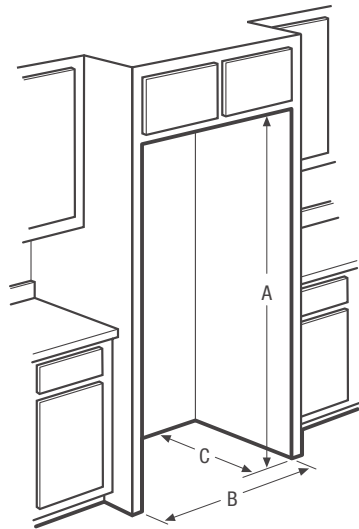

"Built-In Look" Cutout Dimensions

(A) 70 1/4" (B) 36" (C) 28 7/8"

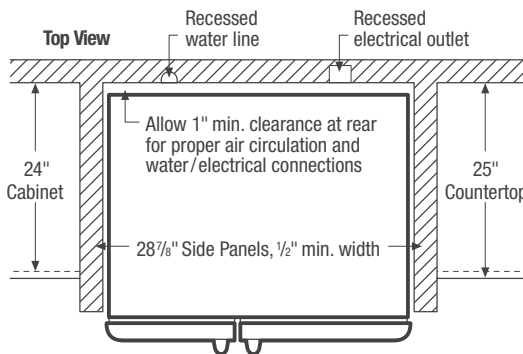
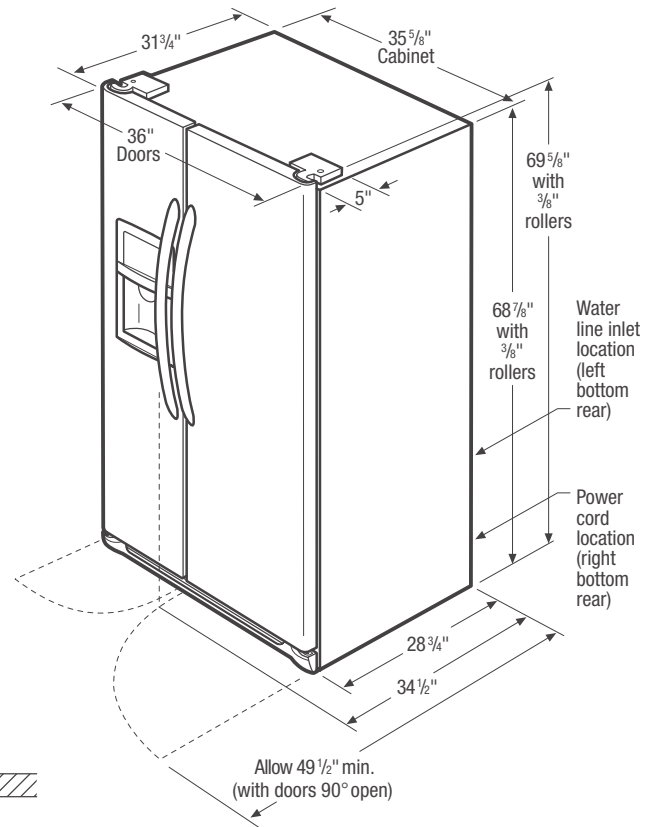

Side-by-Side Refrigerator Specifications

- Product Shipping Weight (approx.) - 293 Lbs.
- Voltage Rating - 120V / 60 Hz / 15 Amps
- Connected Load (kW Rating) @ 120 Volts = 1.02 kW (For use on adequately wired 120V, dedicated circuit having 2-wire service with a separate ground wire. Appliance must be grounded for safe operation.)
- Amps @ 120 Volts = 8.5 Amps
- Always consult local and national electric & plumbing codes.
- Floor should be level surface of hard material, capable of supporting fully loaded refrigerator.
- When installing refrigerator adjacent to wall, cabinet or other appliance that extends beyond front edge of unit, 20" minimum clearance recommended to allow for optimum 120° to 180° door swing, providing complete drawer / crisper access and removal. (*Absolute 4-1/2" minimum clearance will ONLY allow for 90° door swing which will provide drawer / crisper access with restricted removal.*)
- To ensure optimum performance, avoid installing in direct sunlight or close proximity to range, dishwasher or other heat source.
- For proper ventilation, front grille MUST remain unobstructed.

- Recess electrical outlet when possible.
- Water recess on rear wall recommended to prevent water line damage.
- Water Pressure - Cold water line must provide between 30 and 100 pounds per square inch (psi).
- Copper tubing with 1/4" O.D. recommended for water supply line with length equal to distance from rear of unit to household water supply line plus 7 additional feet. Optional Water Supply Installation Kits available.

"Built-In Look" Specifications

- Minimum opening of 70-1/4" H x 36" W x 28-7/8" D required to allow for ease of installation, proper air circulation, and plumbing/electrical connections.
- Remove all wall / floor molding prior to installation.

Note: For planning purposes only. Refer to Product Installation Guide on the web at frigidaire.com for detailed instructions.

Use these dimensions and clearance instructions for planning purposes only. For detailed installation instructions, refer to installation guide, packed with product, or on the web at frigidaire.com.



*When installing side-by-side refrigerator adjacent to wall, cabinet or another appliance that extends beyond front edge of unit, 20" minimum clearance recommended to allow for optimum 120° to 180° door swing, providing complete drawer/crisper access and removal. (Absolute 4-1/2" minimum clearance will ONLY allow for 90° door swing which will provide limited drawer/crisper access with restricted removal.)

When installing appliance with sliding drawer, swinging or drop-down door directly across from obstructions, provide sufficient clearance for drawer extension or door swings.

