



Owner's Manual

Model

DFR2551L

DFR2551G

6908922359

6908922459

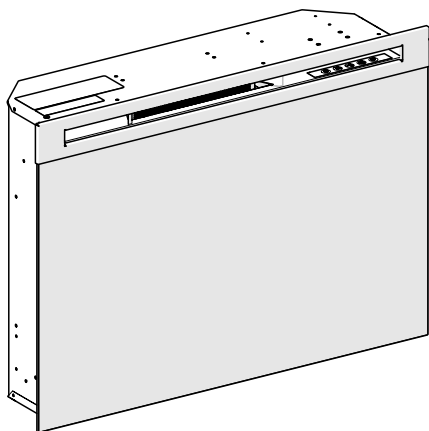







IMPORTANT SAFETY INFORMATION: Always read this manual first before attempting to install or use this fireplace. For your safety, always comply with all warnings and safety instructions contained in this manual to prevent personal injury or property damage.

To view the full line of Dimplex products, please visit www.dimplex.com

7213950100R04



Table of Contents

 Welcome & Congratulations	3
 IMPORTANT INSTRUCTIONS	4
 Fireplace Installation	6
 Operation	9
 Maintenance	13
 Warranty	14
 Technical Support	16

Always use a qualified technician or service agency to repair this fireplace.

! NOTE: Procedures and techniques that are considered important enough to emphasize.

⚠ CAUTION: Procedures and techniques which, if not carefully followed, will result in damage to the equipment.

⚠ WARNING: Procedures and techniques which, if not carefully followed, will expose the user to the risk of fire, serious injury, or death.

Welcome & Congratulations

Thank you and congratulations for purchasing an electric fireplace from Dimplex. Please use our convenient online registration page to record your model and serial numbers for future reference at

www.dimplex.com/register

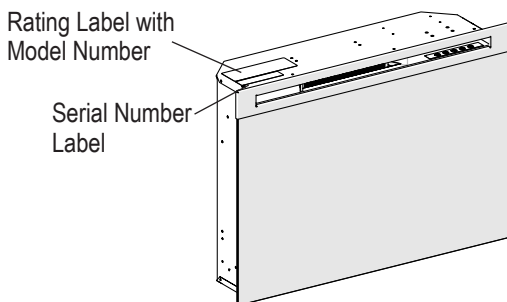

Please carefully read and save these instructions.

⚠ CAUTION: Read all instructions and warnings carefully before starting installation. Failure to follow these instructions may result in a possible electric shock, fire hazard and will void the warranty.



NO NEED TO RETURN TO THE STORE

Questions with operation or assembly? Require Parts Information?
Product Under Manufacturer's Warranty?

Contact us at:  **www.dimplex.com/customer_support**
For Troubleshooting and Technical Support

OR  **Toll-Free 1-888-DIMPLEX (1-888-346-7539)**
Monday to Friday 8:00 a.m. to 4:30 p.m. EST

In order to better serve you, please have your model and serial number ready or register your product online before calling (See above)

IMPORTANT INSTRUCTIONS

When using electrical appliances, basic precautions should always be followed to reduce the risk of fire, electric shock, and injury to persons, including the following:

- ① Read all instructions before using this heater.
- ② This heater is hot when in use. To avoid burns, do not let bare skin touch hot surfaces. The trim around the heater outlet becomes hot during heater operation.
 WARNING: High temperatures may be generated under certain abnormal conditions. Do not partially or fully cover or obstruct the front of this heater.
- ③ Extreme caution is necessary when any heater is used by or near children or invalids and whenever the unit is left operating and unattended.
- ④ Always unplug the heater when not in use.
- ⑤ Do not operate any heater with a damaged cord or plug, or if the heater has malfunctioned, or if it has been dropped or damaged in any manner, contact Dimplex Technical Service at 1-888-346-7539.
- ⑥ Do not use outdoors.

- ⑦ Never locate this heater where it may fall into a bathtub or other water container.
- ⑧ Do not run cord under carpeting. Do not cover cord with throw rugs, runners, or the like. Arrange cord away from traffic area and where it will not be tripped over.
- ⑨ To disconnect heater, turn controls to off, then remove plug from outlet.
- ⑩ Do not insert or allow foreign objects to enter any ventilation or exhaust opening as this may cause an electric shock or fire, or damage the heater.
- ⑪ To prevent a possible fire, do not block air intakes or exhaust in any manner.
- ⑫ All electrical heaters have hot and arcing or sparking parts inside. Do not use in areas where gasoline, paint, or flammable liquids are used or stored.
- ⑬ Do not modify the heater. Use it only as described in this manual. Any other use not recommended by the manufacturer may cause fire, electric shock, or injury to persons.
- ⑭ To reduce the risk of electric shock, this heater has a polarized plug (one blade is wider than the

IMPORTANT INSTRUCTIONS

other). This plug will fit in a polarized outlet only one way. If the plug does not fit fully in the outlet, reverse the plug. If it still does not fit, contact a qualified electrician to install the proper outlet. Do not change the plug in any way. Always plug heaters directly into a wall outlet/receptacle. Never use with an extension cord or relocatable power tap (outlet/power strip).

- ⑮ Do not burn wood or other materials in the fireplace.
- ⑯ Do not strike the front glass.
- ⑰ Always use a certified electrician should new circuits or outlets be required.
- ⑱ Always use properly grounded, fused and polarized outlets.
- ⑲ Disconnect all power supply before performing any cleaning, maintenance or relocation of the heater.
- ⑳ When transporting or storing the heater and cord, keep in a dry place, free from excessive

vibration and store so as to avoid damage.

 **WARNING:** Remote control contains a small battery. Keep away from children. If swallowed, seek medical attention immediately.

 **WARNING:** Do not install battery backwards, charge, put in fire or mix with used or other battery types - may explode or leak causing injury.

! NOTE: Changes or modifications not expressly approved by the party responsible for compliance could void user's authority to operate the equipment.



CAUTION
RISK OF ELECTRIC SHOCK
DO NOT OPEN
NO USER-SERVICEABLE PARTS INSIDE



SAVE THESE INSTRUCTIONS

Fireplace Installation

⚠ WARNING: Ensure the power cord is not installed so that it is pinched or against a sharp edge and ensure that the power cord is stored or secured to avoid tripping or snagging to reduce the risk of fire, electric shock or injury to persons.

⚠ WARNING: Construction and electrical outlet wiring must comply with local building codes and other applicable regulations to reduce the risk of fire, electric shock and injury to persons.

⚠ WARNING: Do not attempt to wire your own new outlets or circuits. To reduce the risk of fire, electric shock or injury to persons, always use a licensed electrician.

⚠ WARNING: To reduce the risk of fire, do not store or use gasoline or other flammable vapors or liquids in the vicinity of the heater.

Front Glass Installation

1. Unpack the glass assembly.
2. If applicable, carefully pour and evenly distribute the supplied media in the Media tray of the firebox. (Figure 2)
3. Hang bottom bracket on screw at the bottom of the firebox. (Figure 1)

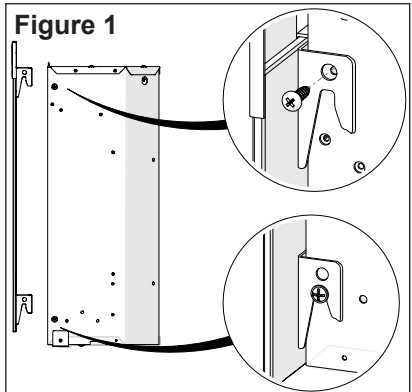

4. Secure the top bracket to firebox using screws provided in the hardware bag. (Figure 1)

Dimplex Mantel Installation

Depending on the available space within the mantel cavity, the unit can be secured to the mantel at the bottom side or back. Remove the screw on the bottom flange in the most appropriate place for securing and using the provided L-bracket and the screw that was removed attach the firebox to the mantel. (Figure 3)

! NOTE: There are no guide holes provided for the L-Brackets in the mantel.

Fireplace Installation

Custom Installation

1. Mark the desired location on the floor and store the fireplace in a safe, dry and dust free location.
2. Frame an opening of 24.0 in. (610 mm) wide x 18 ½ in. (470 mm) high x 7 ⅞ in. (200 mm) deep (Figure 4).

Option #1 - The power cord can be lead from behind the trim and along the wall to an outlet near the fireplace.

Option #2 - A new outlet can be installed inside the new frame construction. Plug the unit directly into a 15 A, 120 V outlet.

! NOTE: A 15 Amp, 120 Volt circuit is required. A dedicated circuit is preferred but not essential in all cases. A dedicated circuit will be required if, after installation, the circuit breaker trips or fuse blows on a regular basis when the heater is operating. Additional appliances on the same circuit may exceed the current rating of the circuit breaker.

3. Install the provided plastic feet to the unit as shown in Figure 5.

⚠ CAUTION: Clearance for air circulation beneath the fireplace insert is provided by feet.

Do not install the fireplace

Figure 2

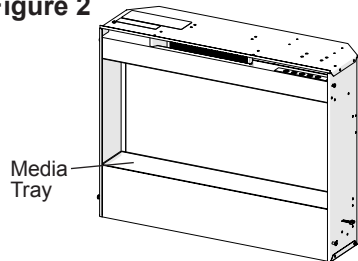

Figure 3

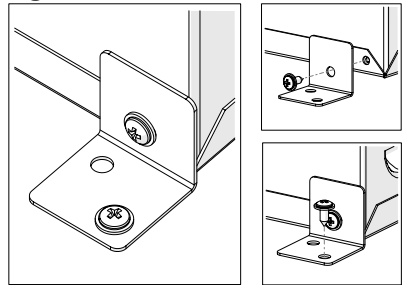
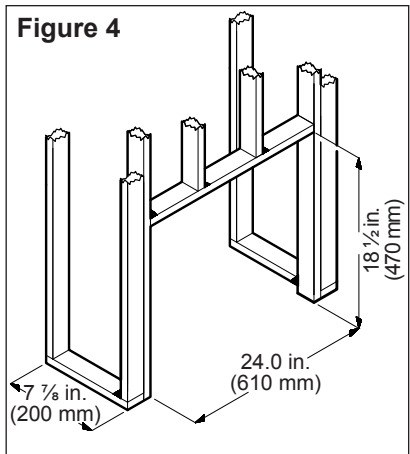

Figure 4



Fireplace Installation

insert directly on carpet or similar surfaces which may restrict air circulation.

CAUTION: If installing the fireplace in a carpeted area, place a one-piece, solid, flat surface under the fireplace. Ensure that all of the feet rest securely on this surface.

- The firebox is to be installed from the front of the mantel and inserted so that the flanges are flush against the front surface of the mantel.

Figure 5

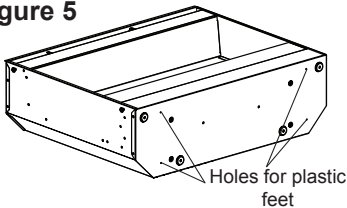

Bathroom Installation

This firebox must be protected by a GFI receptacle or circuit. If a receptacle is used it must be readily accessible.

To prevent electrical shock this unit is an electrical appliance that is not watertight and must be installed as to prevent water from entering the unit. This unit must be installed away from showers, tubs, etc. Never locate fireplace where it may fall into a bathtub or other water containers.

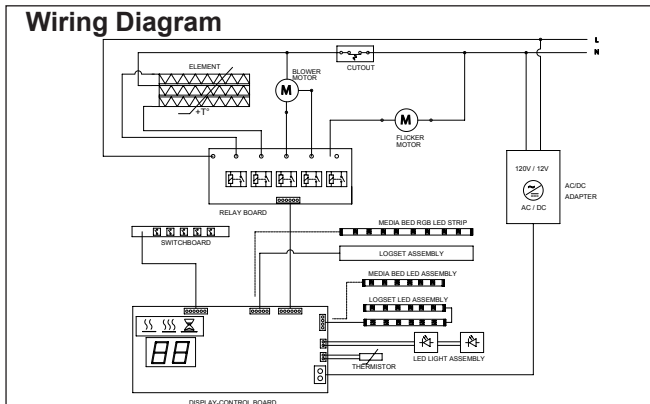

Operation

Figure 6

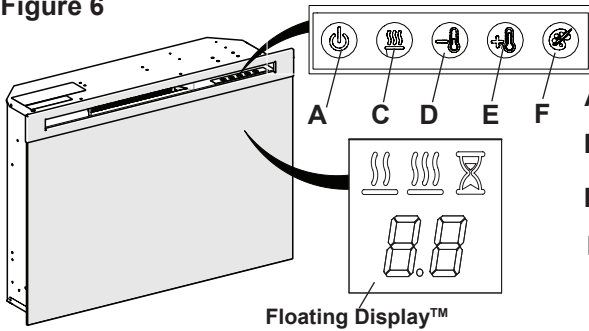
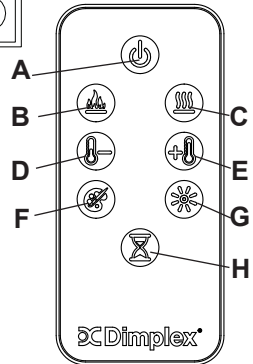

Figure 7



⚠ WARNING: This electric firebox must be properly installed before it is used.

The unit can be controlled by either the manual controls which are located on the upper right of the fireplace or the remote (Figure 6 & 7).

The fireplace is supplied with an IR multifunction remote control. This remote control has a range of approximately 16 ft (5 m). To operate correctly, the remote control must be pointed towards the Floating Display™.

! NOTE: Before attempting any operation with the remote, pull the plastic insulator strip out from between the remote casing and battery cover.

A. Standby

Turns the unit On and Off.

→ Activated by pressing the Standby button on the remote or the unit.

- The unit will turn on with the same functions that it was set to when it was turned Off and the intake temperature will be indicated on the On Screen Display.

! NOTE: When any button is pressed the intake temperature will be displayed on the On Screen Display for 5 seconds.

B. Flame Effects

Turns the flame effect On and Off.



→ Activated by pressing the  button on the remote.

Operation



C. Heat ON/OFF

Cycles the unit sequentially through the 3 settings: Low Heat, High Heat and Off.

→ Activated by pressing the  button on the unit or the remote.

• Indicated by the  (low heat) or the  (high heat) icon and the intake temperature being displayed on the On Screen Display, for 5 seconds before turning off.



! NOTE: After the heater is switched off, there is a 60 second fan delay, where the fan will continue running before turning off.

! NOTE: The unit can be operated in Heat Only Mode. When the unit is only running with the heater, the  (low heat) or the  (high heat) icon and the intake temperature will continuously be displayed on the On Screen Display.



! NOTE: The heater may emit a slight, harmless odor when first used. This odor is a normal condition caused by initial heating of internal heater.

D & E. Thermostat Controls

Adjusts the temperature set point to your individual requirements. Once the desired set temperature is reached the heater will turn off. The heater will cycle on and off to maintain the desired set temperature. The default temperature setting is 72°F (22°C).



→ Adjusted by pressing the  to decrease the setpoint and the  to increase the setpoint on the remote.

• The On Screen Display will indicate the temperature setpoint as it is adjusted.

! NOTE: Holding the  button down, then press  on the unit, will change the temperature from °C to °F, or vice versa.

Disable Heat



If desired, depending on the season, the heater on the unit can be disabled. The unit will operate in the same fashion, with remainder of the controls.

Pressing the  and  buttons on the unit at the same time and holding for 2 seconds will disable

Operation

and enable the heater.

! NOTE: When the heater has been disabled and either the

 or the  is pressed the On Screen Display will indicate "--".

F. Color Themes

Different presets of ambient lighting color combinations contained in the unit.

→ Changed by repeatedly pressing the corresponding button on the remote or the unit.

- Cycles through the different preset ambient lighting settings of the unit, this includes different combinations of colours of the flame and media lighting (if applicable).

! NOTE: The last theme (media versions) or the second to last theme (logset versions) of the cycle is a prism where the unit cycles through a variety of colours.

Pressing the  button stops the cycling and holds the unit on the preferred color, indicated by a solid circle. When the unit is on prism, and is cycling through the colours, a rotating circle will be displayed.

G. Brightness

Changes the brightness of the lights in the unit.

→ Adjusted by repeatedly pressing the corresponding button on the remote.

- Indicated by the second digit on the Floating Display™ changing to show: "H" (high), and "L" (low).

H. Sleep Timer

The Sleep Timer can be set to automatically shut off the fireplace after a preset time (from 30 minutes to 8 hours).

→ To set the timer press the timer button on either the remote or the unit, repeatedly, until the desired time is displayed.

- The On Screen Display will display the different times as it is adjusted. Once the timer has begun, pressing the  button will display the time remaining before the unit turns Off.

! NOTE: The Sleep Timer can be cancelled at any time by

pressing the  button repeatedly until the sleep timer displays nothing.

Operation

Resetting the Temperature Cutoff Switch

Should the heater overheat, an automatic cut out will turn the heater off and it will not come back on without being reset. It can be reset by unplugging the unit and waiting 5 minutes before plugging the unit back in.

⚠ CAUTION: If you need to continuously reset the heater, unplug the unit and call technical support at 1-888-346-7539.

Remote Control Battery Replacement

To replace the battery:

1. On the back of the remote control, slide battery cover open on the remote control.
2. Correctly install one 3 Volt (CR2032 [longer life] or CR2025) battery in the battery holder.
3. Close the battery cover.



Battery must be recycled or disposed of properly. Check with your Local Authority or Retailer for recycling advice in your area



Maintenance

⚠ WARNING: Disconnect power before attempting any maintenance or cleaning to reduce the risk of fire, electric shock or damage to persons.

Glass Cleaning

The glass is cleaned in the factory during the assembly operation. During shipment, installation, handling, etc., the front glass panel may collect dust particles; these can be removed by dusting lightly with a clean dry cloth.

To remove fingerprints or other marks, the front glass panel can be cleaned with a damp cloth. The front glass panel should be completely dried with a lint free cloth to prevent water spots. To prevent scratching, do not use abrasive cleaners or spray liquids on the glass surface.

Fireplace Cleaning

Use warm water only to clean painted surfaces of the Compact Fireplace. Do not use abrasive cleaners.

To prolong the life of your unit and optimize the performance of your heater, vacuum or dust the outlet of the heater, and under and behind your firebox, on a regular basis.

Servicing

Except for the cleaning described above, an authorized service representative should perform any other servicing.



Warranty

One Year Limited Warranty

Products to which this limited warranty applies

This limited warranty applies to your newly purchased Dimplex electric fireplace. This limited warranty applies only to purchases made in any province of Canada *except* for Yukon Territory, Nunavut, or Northwest Territories or in any of the 50 States of the USA (and the District of Columbia) *except* for Hawaii and Alaska. This limited warranty applies to the original purchaser of the product only and is not transferable.

Products excluded from this limited warranty

Light bulbs are not covered by this limited warranty and are the sole responsibility of the owner/purchaser. Products purchased in Yukon Territory, Nunavut, Northwest Territories, Hawaii, or Alaska are not covered by this limited warranty. Products purchased in these States, provinces, or territories are sold AS IS without warranty or condition of any kind (including, without limitation, any implied warranties or conditions of merchantability or fitness for a particular purpose) and the entire risk of as to the quality and performance of the products is with the purchaser, and in the event of a defect the purchaser assumes the entire cost of all necessary servicing or repair.

What this limited warranty covers and for how long

Products covered by this limited warranty have been tested and inspected prior to shipment and, subject to the provisions of this warranty, Dimplex warrants such

products to be free from defects in material and workmanship for a period of 12 months from the date of the first purchase of such product.

The limited 12 month warranty period also applies to any implied warranties that may exist under applicable law. Some jurisdictions do not allow limitations on how long an implied warranty lasts, so the above limitation may not apply to the purchaser.

What this limited warranty does not cover

This limited warranty does not apply to products that have been repaired (except by Dimplex or its authorized service representatives) or otherwise altered. This limited warranty does further not apply to defects resulting from misuse, abuse, accident, neglect, incorrect installation, improper maintenance or handling, or operation with an incorrect power source.

What you must do to get service under this limited warranty

Defects must be brought to the attention of Dimplex Technical Service by contacting Dimplex at 1-888-346-7539, or 1367 Industrial Road, Cambridge Ontario, Canada N3H 4W3. Please have proof of purchase, catalogue/model and serial numbers available when calling. Limited warranty service requires a proof of purchase of the product.

What Dimplex will do in the event of a defect

In the event a product or part covered by this limited warranty is proven to be defective in material or workmanship during the 12 month limited warranty period you have the following rights:



Warranty

- Dimplex will in its sole discretion either repair or replace such defective product or part without charge. If Dimplex is unable to repair or replace such product or part, or if repair or replacement is not commercially practicable or cannot be timely made, Dimplex may, in lieu of repair or replacement, choose to refund the purchase price for such product or part.
- Limited warranty service will be performed solely by dealers or service agents of Dimplex authorized to provide limited warranty services.
- The purchaser is responsible for removal and transportation of such product or part (and any repaired or replacement product or part) to and from the authorized dealer's or service agent's place of business.
- This limited warranty does not entitle the purchaser to on-site or in-home services. On-site or in-home services may be performed at the purchaser's specific request and expense at Dimplex's then-current rates for such services.
- Dimplex will not be responsible for, and the limited warranty services shall not include, any expense incurred for installation or removal of the product or part (or any replacement product or part) or any labour or transportation costs. Such costs shall be the purchaser's responsibility.

What Dimplex and its dealers and service agents are also not responsible for:

IN NO EVENT WILL DIMPLEX, OR ITS

DIRECTORS, OFFICERS, OR AGENTS, BE LIABLE [TO THE PURCHASER OR ANY THIRD PARTY](#), WHETHER IN CONTRACT, IN TORT, OR ON ANY OTHER BASIS, FOR ANY INDIRECT, SPECIAL, PUNITIVE, EXEMPLARY, CONSEQUENTIAL, OR INCIDENTAL LOSS, COST, OR DAMAGE ARISING OUT OF OR IN CONNECTION WITH THE SALE, MAINTENANCE, USE, OR INABILITY TO USE THE PRODUCT, EVEN IF DIMPLEX OR ITS DIRECTORS, OFFICERS, OR AGENTS HAVE BEEN ADVISED OF THE POSSIBILITY OF SUCH LOSSES, COSTS OR DAMAGES, OR IF SUCH LOSSES, COSTS, OR DAMAGES ARE FORESEEABLE. IN NO EVENT WILL DIMPLEX, OR ITS OFFICERS, DIRECTORS, OR AGENTS BE LIABLE FOR ANY DIRECT LOSSES, COSTS, OR DAMAGES THAT EXCEED THE PURCHASE PRICE OF THE PRODUCT.

SOME JURISDICTIONS DO NOT ALLOW THE EXCLUSION OR LIMITATION OF INCIDENTAL OR CONSEQUENTIAL DAMAGES, SO THE ABOVE LIMITATION OR EXCLUSION MAY NOT APPLY TO THE PURCHASER.

How State and Provincial law apply

This limited warranty gives you specific legal rights, and you may also have other rights which vary from jurisdiction to jurisdiction. The provisions of the United Nations Convention on Contracts for the Sale of Goods shall not apply to this limited warranty or the sale of products covered by this limited warranty.



Technical Support

Technical and troubleshooting support, as well as a list of replacement parts can be found on

www.dimplex.com/customer_support.



Dimplex North America Limited

1367 Industrial Road

Cambridge ON

Canada N3H 4W3



© 2016 Dimplex North America Limited