

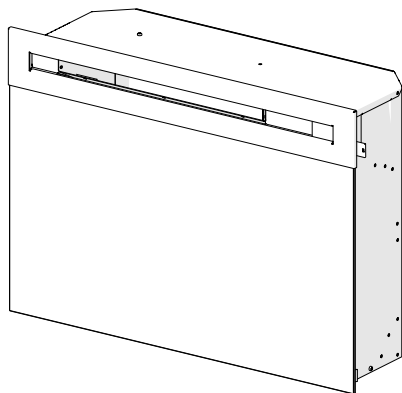

Better solutions through innovation



Owner's Manual

Model

PF2325

PF3033

690932XXXX







IMPORTANT SAFETY INFORMATION: Always read this manual first before attempting to install or use this fireplace. For your safety, always comply with all warnings and safety instructions contained in this manual to prevent personal injury or property damage.

To view the full line of Dimplex products, please visit www.dimplex.com

7213450100R08



Table of Contents

 Welcome & Congratulations	3
 IMPORTANT INSTRUCTIONS.	4
 Fireplace Installation	6
 Operation	10
 Maintenance	15
 Warranty.	16
 Replacement Parts	18

Always use a qualified technician or service agency to repair this fireplace.

! NOTE: Procedures and techniques that are considered important enough to emphasize.

! CAUTION: Procedures and techniques which, if not carefully followed, will result in damage to the equipment.

! WARNING: Procedures and techniques which, if not carefully followed, will expose the user to the risk of fire, serious injury, or death.

Welcome & Congratulations

Thank you and congratulations for purchasing an electric fireplace from Dimplex. Please use our convenient online registration page to record your model and serial numbers for future reference at

www.dimplex.com/register

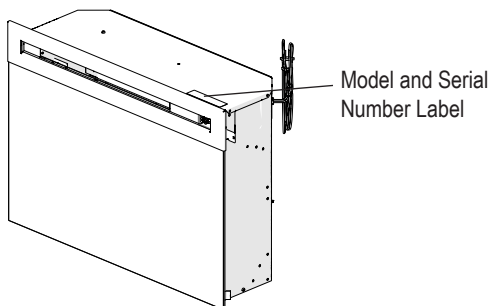



Please carefully read and save these instructions.

⚠ CAUTION: Read all instructions and warnings carefully before starting installation. Failure to follow these instructions may result in a possible electric shock, fire hazard and will void the warranty.

STOP NO NEED TO RETURN TO THE STORE

Questions with operation or assembly? Require Parts Information?
Product Under Manufacturer's Warranty?

Contact us at:  **www.dimplex.com/customer_support**
For Troubleshooting and Technical Support

OR  **Toll-Free 1-888-DIMPLEX (1-888-346-7539)**

Monday to Friday 8:00 a.m. to 4:30 p.m. EST

In order to better serve you, please have your model and serial number ready or register your product online before calling (See above)



IMPORTANT INSTRUCTIONS

When using electrical appliances, basic precautions should always be followed to reduce the risk of fire, electric shock, and injury to persons, including the following:

- ① Read all instructions before using this appliance.
- ② The heater is hot when in use. To avoid burns, do not let bare skin touch hot surfaces. The trim around the heater outlet becomes hot during heater operation.
- ③ Extreme caution is necessary when any heater is used by or near children or invalids and whenever the unit is left operating and unattended.
- ④ Always unplug the fireplace when not in use.
- ⑤ Do not operate any heater after it malfunctions. Disconnect power at the service panel and have the unit inspected by a reputable electrician before reusing.
- ⑥ Do not operate any unit with a damaged cord or plug, or if the heater has malfunctioned, or if the electric fireplace has been dropped or damaged in any manner, contact Dimplex Technical Service at 1-888-346-7539.
- ⑦ Do not use outdoors.
- ⑧ Do not run the cord under carpeting. Do not cover cord with throw rugs, runners or the like. Arrange cord away from traffic area and where it will not be tripped over.
- ⑨ To disconnect the unit, turn the controls off, then remove the plug from the outlet.
- ⑩ Do not insert or allow foreign objects to enter any ventilation or exhaust opening as this may cause an electric shock or fire, or damage to the heater.
- ⑪ To prevent a possible fire, do not block air intake or exhaust in any manner.
- ⑫ All electrical heaters have hot and arcing or sparking parts inside. Do not use in areas where gasoline, paint, or flammable liquids are used or stored.
- ⑬ Do not modify the fireplace. Use it only as described in this manual. Any other use not recommended by the manufacturer may cause fire, electric shock or injury to persons.
- ⑭ To reduce the risk of electric shock, this appliance has a polarized plug (one blade is wider than the other). This plug will fit in a polarized outlet only one way. If the plug does not fit fully in the outlet, reverse the plug. If it still does not fit, contact a qualified electrician to install the proper outlet. Do not change the plug in any way.

IMPORTANT INSTRUCTIONS

⑮ Always plug heaters directly into a wall outlet/receptacle. Never use with an extension cord or relocatable power tap (outlet/power strip).

⑯ Do not burn wood or other materials in the electric fireplace.

⑰ Do not strike the fireplace glass.

⑱ Always use a certified electrician should new circuits or outlets be required.

⑲ Always use properly grounded, fused and polarized outlets.

⑳ Disconnect all power supply before performing any cleaning, maintenance or relocation of the unit.

㉑ When transporting or storing the unit and cord, keep in a dry place, free from excessive vibration and store so as to avoid damage.

 **WARNING:** Remote control contains a small battery. Keep away from children. If swallowed, seek medical attention immediately.

 **WARNING:** Do not install battery backwards, charge, put in fire or mix with used or other battery types - may explode or leak causing injury.

! NOTE: Changes or modifications not expressly approved by the party responsible for compliance could void user's authority to operate the equipment.

 **CAUTION:** Connect to a properly grounded outlet only, see Grounding Instructions.

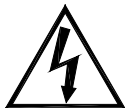

CAUTION
RISK OF ELECTRIC SHOCK
DO NOT OPEN
NO USER-SERVICEABLE PARTS INSIDE



SAVE THESE INSTRUCTIONS

Fireplace Installation

⚠ WARNING: Ensure the power cord is not installed so that it is pinched or against a sharp edge and ensure that the power cord is stored or secured to avoid tripping or snagging to reduce the risk of fire, electric shock or injury to persons.

⚠ WARNING: Construction and electrical outlet wiring must comply with local building codes and other applicable regulations to reduce the risk of fire, electric shock and injury to persons.

⚠ WARNING: Do not attempt to wire your own new outlets or circuits. To reduce the risk of fire, electric shock or injury to persons, always use a licensed electrician.

⚠ WARNING: To reduce the risk of fire, do not store or use gasoline or other flammable vapors or liquids in the vicinity of the heater.

Grounding Instructions

This product must be grounded. If it should malfunction or breakdown, grounding provides a path of least resistance for electric current to reduce the risk of electric shock. This product is equipped with a cord having an equipment-grounding conductor and a grounding plug. The plug must be plugged into an appropriate outlet that is properly installed and grounded in accordance with all local codes and ordinances.

⚠ DANGER: Improper connection of the equipment-grounding conductor can result in a risk of electric shock. Check with a qualified electrician or serviceman if you are in doubt as to whether the product is properly grounded. Do not modify the plug provided with the product – if it will not fit the outlet, have a proper outlet installed by a qualified electrician.

This product is for use on a nominal 120-volt circuit and has a grounding plug that looks like the plug in Figure 1. Make sure that the product is connected to an outlet having the same configuration as the plug. No adapter should be used with this product.

⚠ CAUTION: Clearance for air

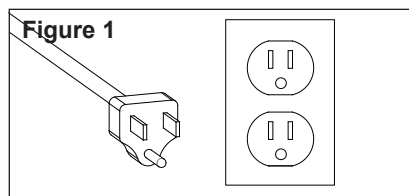

Fireplace Installation

circulation beneath the fireplace insert is provided by 4 felt feet.

Do not install the fireplace insert directly on carpet or similar surfaces which may restrict air circulation.

⚠ CAUTION: If installing the fireplace in a carpeted area, place a one-piece, solid, flat surface under the fireplace. Ensure that all feet rest securely on this surface.

! NOTE: The dimensions of the firebox are:

	Width	Height	Depth
PF2325	24.1in. (612mm)	18.1in. (459mm)	8.9in. (225mm)
PF3033	31.3in. (796mm)	22.5in. (573mm)	8.9in. (226mm)

Mantel Installation

Install the fireplace into the mantel (refer to mantel assembly instructions).

! IMPORTANT: Install the mantel so that it is a minimum of $\frac{3}{8}$ in. (10 mm) off of the wall to ensure adequate air flow.

! IMPORTANT: If not using a Dimplex mantel, the fireplace must be installed in an enclosure with the following **minimum** internal/opening dimensions - Figure 2.

Custom Mantel Construction

1. Frame an opening of, see dimensions in Figure 2:

! NOTE: On elevated installations, the bottom edge and $\frac{1}{2}$ in. (13 mm) up either side will be easily visible after installation (Figure 2). This area should be finished in a manner that is visually appealing and does not restrict air flow to the unit.

Figure 2

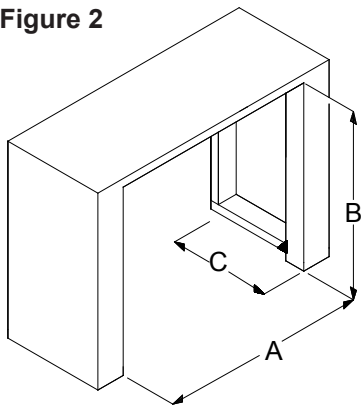

	A	B	C
PF2325	25.0in. (635mm)	18.5in. (470mm)	10.0in. (254mm)
PF3033	32.1in. (816mm)	22.8in. (579mm)	10.0in. (254mm)

! NOTE: The fireplace needs to be installed to ensure 35 in² (226 cm²) of intake air, into the back of the unit, on a continuous basis.



Fireplace Installation

Option #1 - The power cord can be lead from behind the trim and along the wall to an outlet near the fireplace.

Option #2 - A new outlet can be installed inside the new frame construction. Plug the unit into a 15 Amp/120 Volt outlet.

! NOTE: A 15 Amp, 120 Volt circuit is required. A dedicated circuit is preferred but not essential in all cases. A dedicated circuit will be required if, after installation, the circuit breaker trips or fuse blows on a regular basis when the heater is operating. Additional appliances on the same circuit may exceed the current rating of the circuit breaker.

Bathroom Installation

This firebox must be protected by a GFI receptacle or circuit. If a receptacle is used it must be readily accessible.

To prevent electrical shock this unit is an electrical appliance that is not watertight and must be installed as to prevent water from entering the unit. This unit must be installed away from showers, tubs, etc. Never locate fireplace where it may fall into a bathtub or other water containers.

Media Installation

Depending on the model, the media may come installed in the unit or packaged separately.

Installed Media

- No additional steps are required.

Media Separately Packaged

1. Remove the front glass by lifting the 2 hooks off of the 2 mounts on the firebox.
2. Place the large media in the Media Tray in the center at the back (for optimum media effect), then carefully pour and evenly distribute the smaller media into the Media Tray.
3. Replace the front glass.

Figure 3

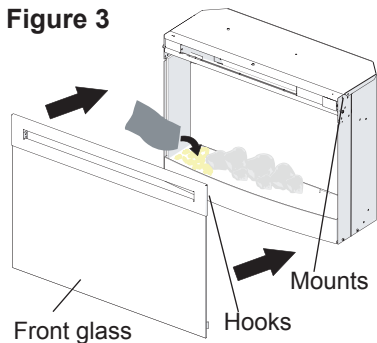



Fireplace Installation

Wiring Diagram

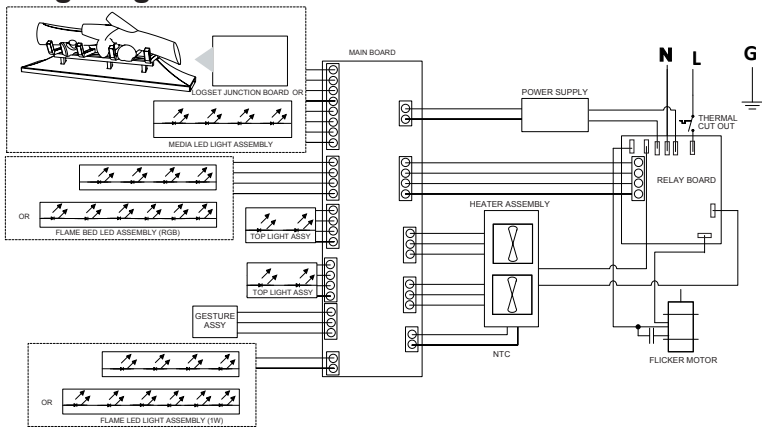

Operation

General Operation

⚠ WARNING: This electric firebox must be properly installed before it is used.

This firebox operates with ComfortSaver™ technology, which automatically adjusts the fan speed and heater wattage to safely and precisely match the requirements of the room based on the thermostat setting. The heater operates such that once the room reaches the set point, the fan and heater will continuously run at a low level, to maintain the desired room temperature. If the temperature in the room rises significantly, i.e. sun coming through a window or a central furnace turns on, the heater and fan will turn off and periodically turn back on to circulate the air around the unit, until the room temperature drops and requires the heater to be constantly on again.

! NOTE: The unit is designed so that the fan will run continuously while the heater is on.

! NOTE: The element retains heat after shutdown, there is a built in cool down period of **1 minute** before the fan shuts off completely.

gWave™ Controls

The fireplace can be operated by a simple "wave" in-front of the unit. By waving your hand vertically approximately 4 in. (102 mm) in-front of the gWave™ sensor in the upper right hand corner of the unit, the unit and different

control functions can be activated. This is also indicated by the LED light turning green.

There is a Gesture On/Off button located below the LED pilot light which can be used to turn this feature On or Off (a more detailed description is located below with the individual feature options). It is recommended that a straightened paperclip be used to press the button through the small hole. When the gWave™ controls are turned off, the green light will flash 4 times before turning off and it will remain solid green when the gWave™ controls are active.

! NOTE: The unit is programmed to have a built in demonstration mode to exhibit all of the functions of the unit in a 95 second period of time. This can be activated by holding your hand in front of the gWave™ sensor for 7 seconds. When the unit has gone through the demonstration mode once it will return to the previous operation.

Remote Operation

The fireplace is supplied with an IR multifunction remote control.

! NOTE: To operate correctly, the remote control must be pointed towards the front of the unit.

Controls

1.  **Standby:** Turns unit On or Off.
→ Activated by pressing the corresponding button on the remote

Operation

Figure 4

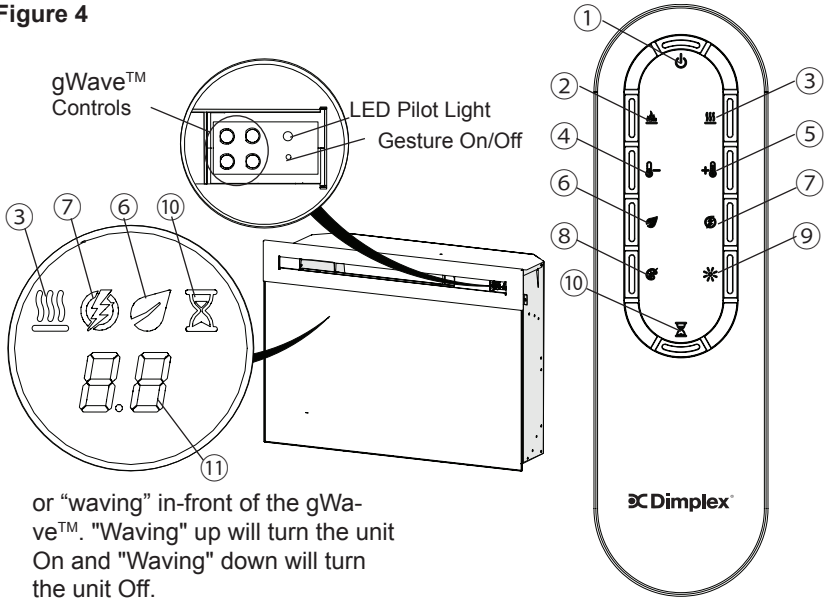

or "waving" in-front of the gWave™. "Waving" up will turn the unit On and "Waving" down will turn the unit Off.

- The unit will turn on with the same functions that it was set to when it was turned Off and the intake temperature will be indicated on the On Screen Display.

! NOTE: When any button is pressed the intake temperature will be displayed on the On Screen Display for 5 seconds.

2.  Flame On/Off: Turns the flame effect On or Off.

→ Activated by pressing the corresponding button on the remote or "waving" in-front of the gWave™.

- When On the flame effect is visible in the unit.

3.  Heat On/Off: Turns the heater On or Off.

→ Activated by pressing the corresponding button on the remote or holding your hand in-front of the gWave™ for 3 seconds.

- Indicated by the icon and intake temperature being illuminated on the Floating Display™ and the heater turning On or Off.

! NOTE: The heater can be operated when the flame is not visible. In this case the  icon will remain on

Operation

the Floating Display™ until the heater is turned off or the flames are turned back on.

4.  **Temperature Down:** Decreases the heat output.

→ Adjusted by repeatedly pressing the corresponding button on the remote.*

• Indicated by setpoint temperature on the Floating Display™ decreasing and the speed of the fan decreasing to reduce the amount of heat being projected into the room.**



5.  **Temperature Up:** Increases the heat output.

→ Adjusted by repeatedly pressing the corresponding button on the remote.*

• Indicated by the setpoint on the Floating Display™ increasing and the speed of the fan increasing to increase the amount of heat being projected into the room.

* The first time the button is pressed the current temperature set point will be displayed for 5 seconds.

** The temperature can be adjusted from 5 °C to 30 °C (41 °F to 86 °F).

! **NOTE:** Pressing and holding the , then pressing , will toggle between °C and °F.

6.  **Eco:** Runs the heater in a reduced wattage range when

activated.

→ Adjusted by pressing the corresponding button on the remote when the heater is on.

• Indicated by the icon being illuminated on the Floating Display™ and the speed of the fan will decrease proportionally.

7.  **Boost:** Turns On/Off the heater boost function. Runs the unit at the full rated wattage.

→ Activated and adjusted by repeatedly pressing the corresponding button on the remote.

• Indicated by the heater running at full heat, for a predetermined amount of time, to quickly heat up a cold room/space. The Boost can be set for a maximum of 20 minutes, in 5 minute increments.

8.  **Multi-Fire XD™:** Different presets of ambient lighting color combinations contained in the unit.







→ Changed by repeatedly pressing the corresponding button on the remote.

• Cycles through the different preset ambient lighting settings of the unit, this includes different combinations of colours of the top lighting, flame base and media lighting (if applicable).

! **NOTE:** The last option is a personalized colour setting ("P"), where

Operation

using the buttons on the remote the lighting of the unit can be adjusted to any shade of any colour. The initial setting is no light (R=0, B=0, G=0) and can be adjusted, while the display is flashing, by pressing the outlined buttons (below) to adjust the tones.

- Red Tones:  increase and the  decrease.
- Green Tones:  increase and  decrease.
- Blue Tones:  increase and  decrease.

! NOTE: There are 25 different settings for each colour.

9.  **Brightness:** Changes the brightness of the lights in the unit.

→ Adjusted by repeatedly pressing the corresponding button on the remote.

• Indicated by the second digit on the Floating Display™ changing to show: "A" (high), "b" (low), "C" (high with media flicker) and "d" (low with media flicker).

! NOTE: Media flicker is not an option on the Multi-Fire XD™ levels 5, 6 or P.

10.  **Sleep timer:** turns the unit off after a preset duration (from 30 minutes (0.5h) to 8 hours, in ½ hour increments).

→ Activated and adjusted by repeatedly pressing the corresponding button on the remote.



• Indicated by the Floating Display™ changing to indicate 30 minutes (0.5 h) through 8 hours. The fireplace will automatically turn off when the sleep timer reaches zero minutes. The sleep timer can be cancelled at any time by pressing the sleep timer button repeatedly until the sleep timer will no longer be visible.

11. Numerical Display

→ Default display will be the heater air intake temperature or settings (eg. Multifire XD, Brightness, etc.)

Disable Heat

If desired, depending on the season, the heater on the unit can be disabled. The unit will operate in the same fashion, with remainder of the controls.

Pressing the  then  will enable or disable the heater. When in the heat disable mode the temperature reading/setting on the On Screen Display displays nothing ("--").

! NOTE: The heat will not work in manual controls either.

Operation

Resetting the Temperature Cutoff Switch

Should the heater overheat, an automatic cut out will turn the fireplace off and it will not come back on without being reset. It can be reset by unplugging the unit and waiting 15 minutes before plugging the unit back in.

Once power is restored the unit will start to reset itself. During this process you will hear repeated beeps and the display may turn on and off.

 **CAUTION:** If you need to continuously reset the heater, disconnect power and call Dimplex customer service at 1-888-DIMPLEX (1-888-346-7539).

Battery Replacement (Figure 4)

To replace the battery:

1. Slide battery cover open on the back of the remote control.
2. Install one 3V (CR 2032) battery in the battery holder.
3. Close the battery cover.



Battery must be recycled or disposed of properly. Check with your Local Authority or Retailer for recycling advice in your area.



Maintenance

⚠ WARNING: Disconnect power before attempting any maintenance or cleaning to reduce the risk of fire, electric shock or damage to persons.

⚠ CAUTION: Allow adequate time for the element and body casing to cool before attempting to clean the unit.

It is suggested that the heater be inspected regularly, for cleanliness of the fan exhaust and intake grille, to ensure optimal performance is maintained. The grille can be cleaned by vacuuming off all dust and dirt.

Glass Cleaning

The front glass is cleaned in the factory during the assembly operation. During shipment, installation, handling, etc., the front glass may collect dust particles, these can be removed by dusting lightly with a clean dry cloth.

To remove fingerprints or other marks, the glass can be cleaned with a damp cloth. The glass should be completely dried with a lint free cloth to prevent water spots. To prevent

scratching, do not use abrasive cleaners or spray liquids on the glass surface.

Fireplace Surface Cleaning

To remove fingerprints or other marks, the exterior finish can be cleaned with a damp cloth with a mild detergent. The surface should be completely dried with a lint free cloth to prevent water spots.

Servicing

Except for installation and cleaning described in this manual, an authorized service representative should perform any other servicing.

Warranty

Products to which this limited warranty applies

This limited warranty applies to the following models of your newly purchased Dimplex electric fireplace 690932XXXX and to newly purchased Dimplex fireplace surrounds and trims. This limited warranty applies only to purchases made in any province of Canada except for Yukon Territory, Nunavut, or Northwest Territories or in any of the 50 States of the USA (and the District of Columbia) except for Hawaii and Alaska. This limited warranty applies to the original purchaser of the product only and is not transferable.

Products excluded from this limited warranty

Products purchased in Yukon Territory, Nunavut, Northwest Territories, Hawaii, or Alaska are not covered by this limited warranty. Products purchased in these States, provinces, or territories are sold AS IS without warranty or condition of any kind (including, without limitation, any implied warranties or conditions of merchantability or fitness for a particular purpose) and the entire risk of as to the quality and performance of the products is with the purchaser, and in the event of a defect the purchaser assumes the entire cost of all necessary servicing or repair.

What this limited warranty covers and for how long

Products, other than fireplace surrounds (mantels) and trims, covered by this limited warranty have been tested and inspected prior to shipment and, subject to the provisions of this warranty, Dimplex warrants such products to be free from defects in material and workmanship for a

period of 1 year from the date of the first purchase of such products.

The limited 1 year warranty period also applies to any implied warranties that may exist under applicable law. Some jurisdictions do not allow limitations on how long an implied warranty lasts, so the above limitation may not apply to the purchaser.

What this limited warranty does not cover

This limited warranty does not apply to products that have been repaired (except by Dimplex or its authorized service representatives) or otherwise altered. This limited warranty does further not apply to defects resulting from misuse, abuse, accident, neglect, incorrect installation, improper maintenance or handling, or operation with an incorrect power source.

What you must do to get service under this limited warranty

Defects must be brought to the attention of Dimplex Technical Service by contacting Dimplex at 1-888-DIMPLEX (1-888-346-7539), or 1367 Industrial Road, Cambridge Ontario, Canada N1R 7G8. Please have proof of purchase, catalogue/ model and serial numbers available when calling. Limited warranty service requires a proof of purchase of the product.

What Dimplex will do in the event of a defect?

In the event a product or part covered by this limited warranty is proven to be defective in material or workmanship during the 1 year limited warranty period you have the following rights:

- Dimplex will in its sole discretion either repair or replace such defective



Warranty

product or part without charge. If Dimplex is unable to repair or replace such product or part, or if repair or replacement is not commercially practicable or cannot be timely made, Dimplex may, in lieu of repair or replacement, choose to refund the purchase price for such product or part.

- Limited warranty service will be performed solely by dealers or service agents of Dimplex authorized to provide limited warranty services.
- Dimplex will not be responsible for, and the limited warranty services shall not include, any expense incurred for installation or removal of the product or part (or any replacement product or part) or any labour or transportation costs. Such costs shall be the purchaser's responsibility.

What Dimplex and its dealers and service agents are also not responsible for:

IN NO EVENT WILL DIMPLEX, OR ITS DIRECTORS, OFFICERS, OR AGENTS, BE LIABLE TO THE PURCHASER OR ANY THIRD PARTY, WHETHER IN CONTRACT, IN TORT, OR ON ANY OTHER BASIS, FOR ANY INDIRECT, SPECIAL, PUNITIVE, EXEMPLARY, CONSEQUENTIAL, OR INCIDENTAL LOSS, COST, OR DAMAGE ARISING OUT OF OR IN CONNECTION WITH THE SALE, MAINTENANCE, USE, OR INABILITY TO USE THE PRODUCT, EVEN IF DIMPLEX OR ITS DIRECTORS, OFFICERS, OR AGENTS HAVE BEEN ADVISED OF THE POSSIBILITY OF SUCH LOSSES, COSTS OR DAMAGES, OR IF SUCH LOSSES, COSTS, OR DAMAGES ARE FORESEEABLE. IN

NO EVENT WILL DIMPLEX, OR ITS OFFICERS, DIRECTORS, OR AGENTS BE LIABLE FOR ANY DIRECT LOSSES, COSTS, OR DAMAGES THAT EXCEED THE PURCHASE PRICE OF THE PRODUCT.

SOME JURISDICTIONS DO NOT ALLOW THE EXCLUSION OR LIMITATION OF INCIDENTAL OR CONSEQUENTIAL DAMAGES, SO THE ABOVE LIMITATION OR EXCLUSION MAY NOT APPLY TO THE PURCHASER.

How State and Provincial law apply

This limited warranty gives you specific legal rights, and you may also have other rights which vary from jurisdiction to jurisdiction. The provisions of the United Nations Convention on Contracts for the Sale of Goods shall not apply to this limited warranty or the sale of products covered by this limited warranty.



Replacement Parts

Flicker Motor	2000480100RP
Heater Assembly (with cutout)	2203650100RP
Cord Set	4100190400RP
Remote Control	3001250100RP
Main Control Board with Display	3001530100RP
gWave™ Assembly	3001620100RP
Relay Board	3001540100RP
Power Supply	2100250300RP
Logset Junction Board	3001600100RP
Top Light Assembly	3001290100RP

	PF23	PF33
Log Set	0441690200RP	0441540200RP
Media Tray (Flat)	0441580100RP	0441580200RP
Front Glass (Flat)	1026770400RP	1026770600RP
Media Tray (Curved)	0441580300RP	N/A
Front Glass (Curved)	1026770700RP	N/A
Partially Reflective Glass	5902750100RP	5902750400RP
Brick Panels	0441600100RP	0441600300RP
Flicker Assembly	5902830100RP	5902830200RP
Media LED Light Assembly	3001330700RP	3001330600RP
Ember LED Light Assembly	3001300100RP	3001300200RP
Flame LED Light Assembly (1W)	3001310100RP	3001310300RP
Flame Bed LED Assembly (RGB)	3001330200RP	3001330400RP



Dimplex North America Limited

1367 Industrial Road
Cambridge ON
Canada N1R 7G8